



vision solution

Specification

SBS-SCJ158-0.516

High Resolution Double Telecentric Lens

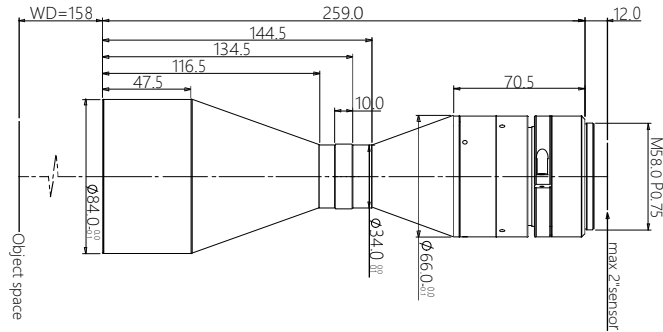

Features (SBS-SCJ series)

- * Excellent double telecentric design for high resolution image result.
- * Field of view is from 26mm to 300mm, suitable for most of application.
- * Big Iris, low distortion, high parallel degree, big depth of view.
- * Sensor size is available for 1/2.5" 1/2" 1/1.8" 2/3" 1" 4/3" 1.75" 2" $\phi 39$ 35mm full.

Parameters

FOV (Dia.mm)	64
Mag.(x)	0.516
WD (mm)	158 \pm 3
Sensor size (Dia.mm)	33(2")
Image F#	9.7
Image MTF30(pl/mm)	>90
Object DOF (mm)	\pm 3.3@F20
Object distortion (%)	<0.1
Object telecentric degree	<0.1
Object I/O(mm)	429 \pm 3

Mechanical

Mount	M42/M48/M58
Total length (mm)	259.0
N.W(KG)	1.4

Field of View (mm x mm)

2" DALSA 12M (24.58x18.43)	47.6x35.7
2" PYTHON 25K (23.04x23.04)	44.7x44.7