

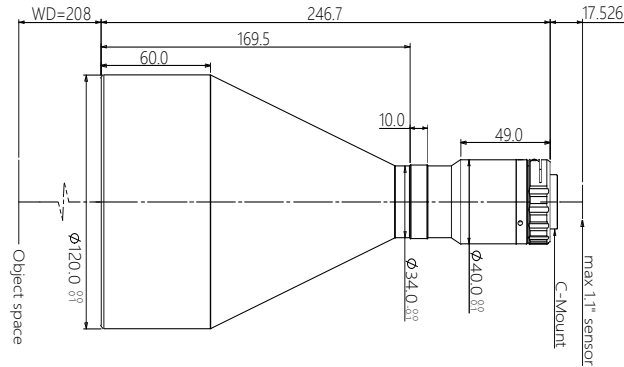

vision solution

Specification

SBS-SCJ208-0.204 High Resolution Double Telecentric Lens



Features (SBS-SCJ series)

- * Excellent double telecentric design for high resolution image result.
- * Field of view is from 26mm to 300mm, suitable for most of application.
- * Big Iris, low distortion, high parallel degree, big depth of view.
- * Sensor size is available for 1/2.5" 1/2" 1/1.8" 2/3" 1" 4/3" 1.75" 2" Φ39 35mm full.

Parameters

FOV (Dia.mm)	90
Mag.(x)	0.204
WD (mm)	208±3
Sensor size (Dia.mm)	18.4(1.1")
Image F#	6.2
Image MTF30(pl/mm)	>145
Object DOF (mm)	±10.5@F11
Object distortion (%)	<0.1
Object telecentric degree	<0.1
Object I/O(mm)	472±3

Mechanical

Mount	C
Total length (mm)	246.7
N.W(KG)	1.8

Field of View (mm x mm)

1" IMX183 (13.13x8.76)	64.4x42.9
1.1" IMX253 (14.19x10.38)	69.6x50.9