



vision solution

# Specification

## SBS-SCJ258-0.24

High Resolution Double Telecentric Lens

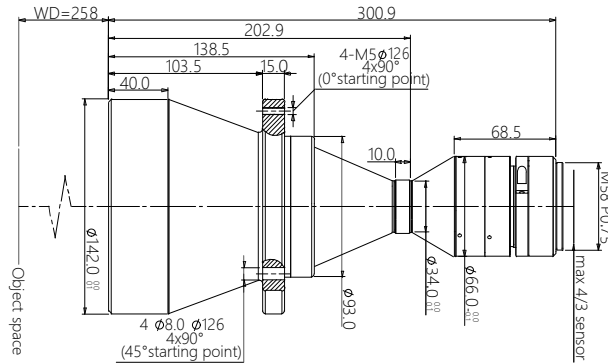

### Features (SBS-SCJ series)

- \* Excellent double telecentric design for high resolution image result.
- \* Field of view is from 26mm to 300mm, suitable for most of application.
- \* Big Iris, low distortion, high parallel degree, big depth of view.
- \* Sensor size is available for 1/2.5" 1/2" 1/1.8" 2/3" 1" 4/3" 1.75" 2" Φ39 35mm full.

### Parameters

FOV (Dia.mm)	100
Mag.(x)	0.240
WD (mm)	258±4
Sensor size (Dia.mm)	24(4/3")
Image F#	9.4
Image MTF30(pl/mm)	>95
Object DOF (mm)	±13.8@F20
Object distortion (%)	<0.1
Object telecentric degree	<0.1
Object I/O(mm)	571±4

### Mechanical

Mount	M42/M48/M58
Total length (mm)	300.9
N.W(KG)	3.5

### Field of View (mm x mm)

4/3" Keyence 21M (17.86x14.32)	74.4x59.7
4/3" PYTHON 12K (18.43x13.82)	76.8x57.6
4/3" CMV8000 (18.48x13.73)	77.0x57.2