



vision solution

Specification

SBS-SCJ273-0.067

High Resolution Double Telecentric Lens

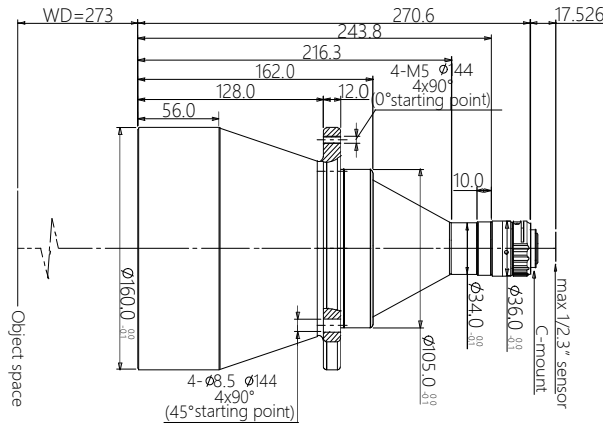

Features (SBS-SCJ series)

- * Excellent double telecentric design for high resolution image result.
- * Field of view is from 26mm to 300mm, suitable for most of application.
- * Big Iris, low distortion, high parallel degree, big depth of view.
- * Sensor size is available for 1/2.5" 1/2" 1/1.8" 2/3" 1" 4/3" 1.75" 2" Φ39 35mm full.

Parameters

FOV (Dia.mm)	120
Mag.(x)	0.067
WD (mm)	273±5
Sensor size (Dia.mm)	8.0(1/2")
Image F#	4.2
Image MTF30(pl/mm)	>210
Object DOF (mm)	±99@F11
Object distortion (%)	<0.1
Object telecentric degree	<0.1
Object I/O(mm)	561±5

Mechanical

Mount	C
Total length (mm)	270.6
N.W(KG)	4.1

Field of View (mm x mm)

1/2.5" 9P001/31 (5.7x4.28)	85.1x63.9
1/2.3" 9J003 (6.44x4.62)	96.1x69.0