

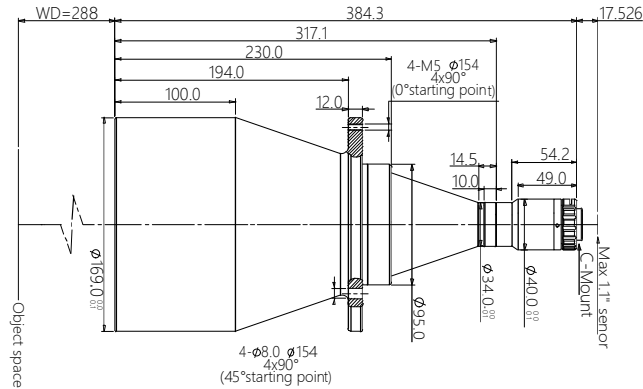

vision solution

Specification

SBS-SCJ288-0.135 High Resolution Double Telecentric Lens



Features (SBS-SCJ series)

- * Excellent double telecentric design for high resolution image result.
- * Field of view is from 26mm to 300mm, suitable for most of application.
- * Big Iris, low distortion, high parallel degree, big depth of view.
- * Sensor size is available for 1/2.5" 1/2" 1/1.8" 2/3" 1" 4/3" 1.75" 2" ϕ 39 35mm full.

Parameters

FOV (Dia.mm)	136
Mag.(x)	0.135
WD (mm)	288 \pm 5
Sensor size (Dia.mm)	18.4(1.1")
Image F#	6.2
Image MTF30(pl/mm)	>150
Object DOF (mm)	\pm 24.1@F11
Object distortion (%)	<0.1
Object telecentric degree	<0.1
Object I/O(mm)	690 \pm 5

Mechanical

Mount	C
Total length (mm)	384.3
N.W(KG)	4.3

Field of View (mm x mm)

1" IMX183 (13.13x8.76)	97.3x64.9
1.1" IMX253 (14.19x10.38)	105.1x76.9