



vision solution

Specification

SBS-SCJ300-0.076

High Resolution Double Telecentric Lens

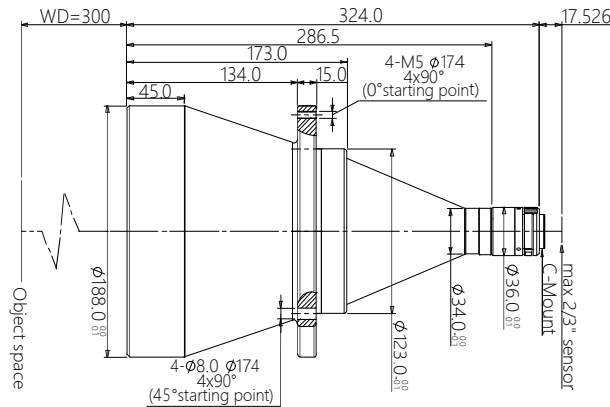

Features (SBS-SCJ series)

- * Excellent double telecentric design for high resolution image result.
- * Field of view is from 26mm to 300mm, suitable for most of application.
- * Big Iris, low distortion, high parallel degree, big depth of view.
- * Sensor size is available for 1/2.5" 1/2" 1/1.8" 2/3" 1" 4/3" 1.75" 2" Φ39 35mm full.

Parameters

FOV (Dia.mm)	150
Mag.(x)	0.076
WD (mm)	300±5
Sensor size (Dia.mm)	11.4(2/3")
Image F#	4.9
Image MTF30(pl/mm)	>185
Object DOF (mm)	±76.1@F11
Object distortion (%)	<0.1
Object telecentric degree	<0.1
Object I/O(mm)	642±5

Mechanical

Mount	C
Total length (mm)	324.0
N.W(KG)	5.7

Field of View (mm x mm)

1/1.8" EV76C570 (7.2x5.4)	94.7x71.1
1/1.7" IMX226 (7.5x5.6)	98.7x73.7
2/3" IMX250/264 (8.45x7.1)	111.2x93.4