



vision solution

# Specification

## SBS-SCJ410-0.03

High Resolution Double Telecentric Lens

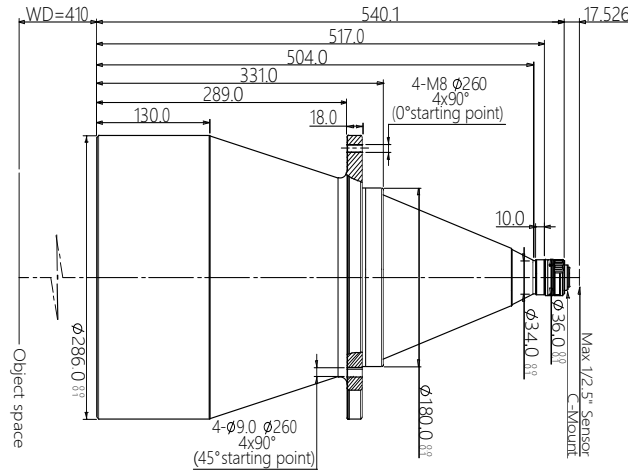

### Features (SBS-SCJ series)

- \* Excellent double telecentric design for high resolution image result.
- \* Field of view is from 26mm to 300mm, suitable for most of application.
- \* Big Iris, low distortion, high parallel degree, big depth of view.
- \* Sensor size is available for 1/2.5" 1/2" 1/1.8" 2/3" 1" 4/3" 1.75" 2" Φ39 35mm full.

### Parameters

FOV (Dia.mm)	240
Mag.(x)	0.030
WD (mm)	410±6
Sensor size (Dia.mm)	7.2(1/2.5")
Image F#	4.2
Image MTF30(pl/mm)	>210
Object DOF (mm)	±489@F11
Object distortion (%)	<0.1
Object telecentric degree	<0.1
Object I/O(mm)	968±6

### Mechanical

Mount	C
Total length (mm)	540.1
N.W(KG)	19.1

### Field of View (mm x mm)

1/3" AR130/RJ33 (4.8x3.6)	160.0x120.0
1/2.5" 9P001/31 (5.7x4.28)	190.0x142.7