



vision solution

# Specification

## SBS-SCJ73-0.346

High Resolution Double Telecentric Lens

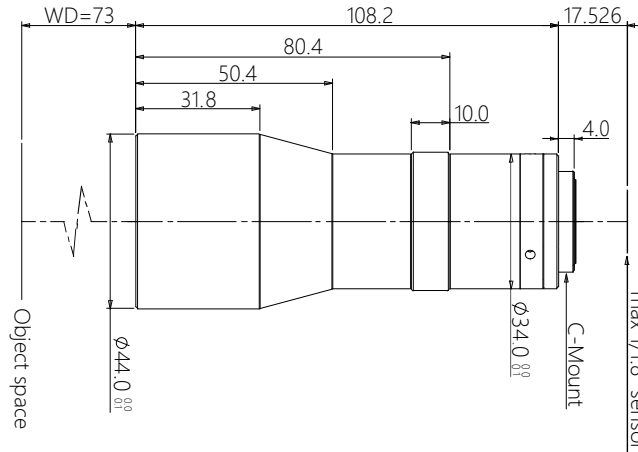

### Features (SBS-SCJ series)

- \* Excellent double telecentric design for high resolution image result.
- \* Field of view is from 26mm to 300mm, suitable for most of application.
- \* Big Iris, low distortion, high parallel degree, big depth of view.
- \* Sensor size is available for 1/2.5" 1/2" 1/1.8" 2/3" 1" 4/3" 1.75" 2" Φ39 35mm full.

### Parameters

FOV (Dia.mm)	26
Mag.(x)	0.346
WD (mm)	73±1
Sensor size (Dia.mm)	9.0(1/1.8")
Image F#	4.6
Image MTF30(pl/mm)	>170
Object DOF (mm)	±3.7@F11
Object distortion (%)	<0.1
Object telecentric degree	<0.1
Object I/O(mm)	199±1

### Mechanical

Mount	C
Total length (mm)	108.2
N.W(KG)	0.3

### Field of View (mm x mm)

1/1.8" IMX178 (7.43x4.9)	21.5x14.2
1/1.8" IMX252/265 (7.1x5.3)	20.5x15.3