

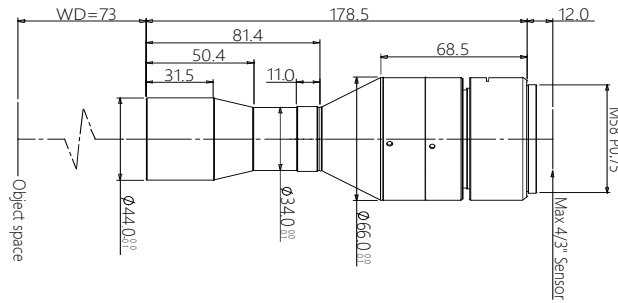

vision solution

Specification

SBS-SCJ73-0.923 High Resolution Double Telecentric Lens



Features (SBS-SCJ series)

- * Excellent double telecentric design for high resolution image result.
- * Field of view is from 26mm to 300mm, suitable for most of application.
- * Big Iris, low distortion, high parallel degree, big depth of view.
- * Sensor size is available for 1/2.5" 1/2" 1/1.8" 2/3" 1" 4/3" 1.75" 2" $\phi 39$ 35mm full.

Parameters

FOV (Dia.mm)	26
Mag.(x)	0.923
WD (mm)	73 \pm 1
Sensor size (Dia.mm)	24(4/3")
Image F#	12.5
Image MTF30(pl/mm)	>65
Object DOF (mm)	\pm 0.9@F20
Object distortion (%)	<0.1
Object telecentric degree	<0.1
Object I/O(mm)	264 \pm 1

Mechanical

Mount	M42/M48/M58
Total length (mm)	178.5
N.W(KG)	0.8

Field of View (mm x mm)

4/3" Keyence 21M (17.86x14.32)	19.3x15.5
4/3" PYTHON 12K (18.43x13.82)	20.0x15.0
4/3" CMV8000 (18.48x13.73)	20.0x14.9