

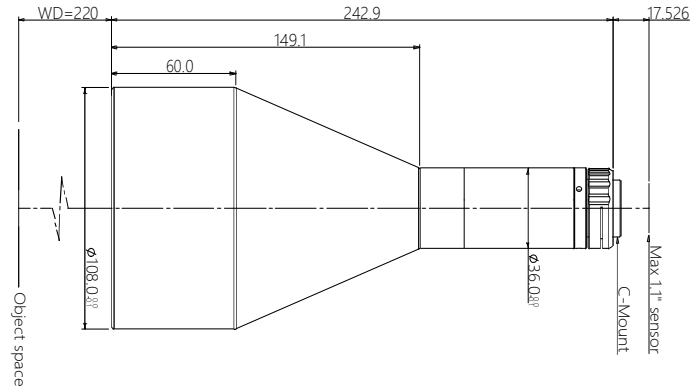

vision solution

Specification

SBS-YXDX220-0.275
Big Sensor Size Telecentric Lens



Features (SBS-YXDX series)

- * Large FOV with low magnification.
- * Big working distance easy for illuminations and object allocation design.
- * High accuracy, low distortion, high telecentricity.
- * support up to 1.1" 12M class high-speed camera.

Parameters

Mag.(x)	0.275
WD (mm)	220±3
Sensor size (Dia.mm)	18.0(1.1")
Image F#	8
Image MTF30(pl/mm)	>105
Object DOF (mm)	±4.2@F8
Object distortion (%)	<0.1
Object telecentric degree	<0.15

Mechanical

Mount	C
Total length (mm)	242.9
Coaxial structure	N

Field of View (mm x mm)

1" IMX183 (13.13x8.76)	47.7x31.9
1.1" IMX253 (14.19x10.38)	51.6x37.7